

VETRINO

made to measure sliding doors designed for your space





VETRINO

**We are passionate about creating beautiful
bespoke sliding doors.**

Our doors are manufactured to be as aesthetic as
they are functional. The Vetrino collection is
designed to reflect your individuality while
transforming your space.

This brochure explores a sliding door system that
is completely bespoke to your unique style,
offers a vast choice of finishes, and is designed
with quality in mind.

Your design is our standard



Photo by Roger Bradshaw for Unsplash

Made in England

A beautiful peaceful setting, nestled in the south-east of Leicestershire, just a stone's throw away from the River Soar. It is here that every piece of the Vetrino range is built by hand by our expert technicians.

Within the workshop, state-of-the-art machinery enhances the traditional hands-on skills of our craftsmen, our secret is the quality of the product and our attention to innovation.



Photo by Daniel McCullough for Unsplash

Personalised for you

By inviting Vetrino into your home you have the opportunity to create a space that perfectly represents you.

The highly bespoke nature of the collection ensures a completely personalised product, with the emphasis on quality and a meticulous attention to detail.



Creating beautiful bespoke interiors

The **Vetrino** collection features three elegant handle profiles, a variety of door styles, as well as an extensive selection of mirrors, coloured glass, and decorative panels.



Linear

A simple angular design with a large grip that will give your interior a contemporary feel.

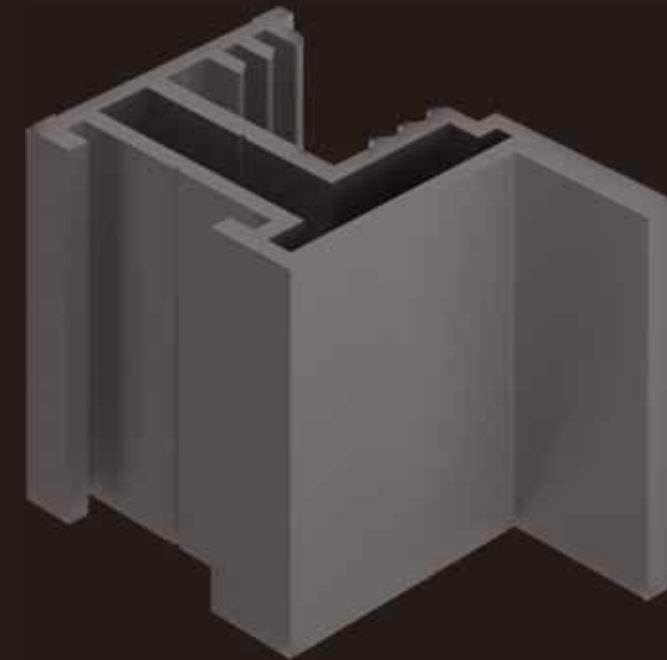



Having sliding doors in your hobby or studio room allows you to create a dedicated area for your activities, enabling you to store equipment away and out of sight and repurpose the space.

Utilise your space

Linear, Satin Champagne

Simple and sleek, the Linear handle has a modern profile with a large grip and a square design.

The Linear handle profile in Satin Champagne, with a multi-line configuration, accents this three door studio storage solution.

Panels finished in Cashmere Grey MFC, Bronze Tinted Mirror and Stone Grey Glass.

12.50%
12.50%
25%
25%
12.50%
12.50%

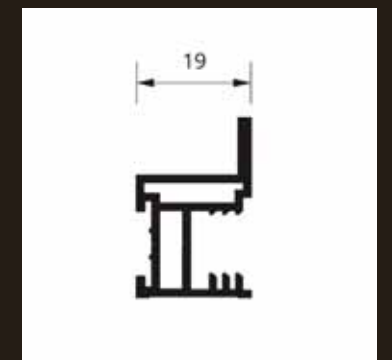
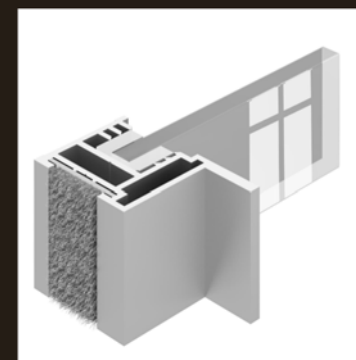
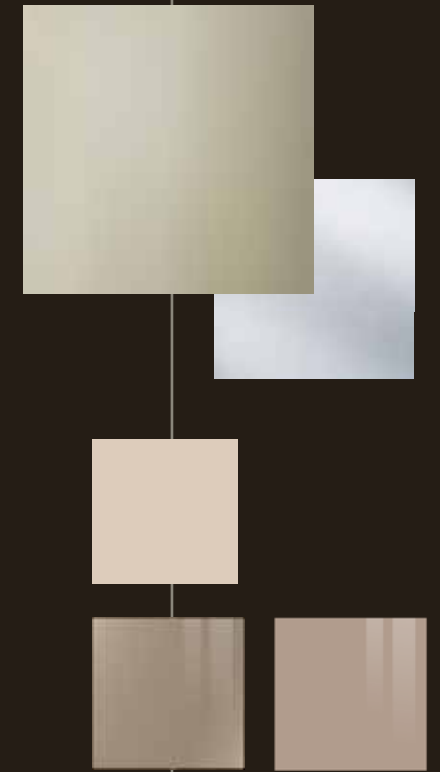

Linear

Versatility

Linear, Satin Silver

Simple and sleek, the Linear handle has a modern profile with a large grip and a square design.

Using four doors in this four panel configuration, this dining room storage solution features the Linear handle profile in Satin Silver.

Panels are in Anthracite Metal Rock MFC and Pure White Glass.

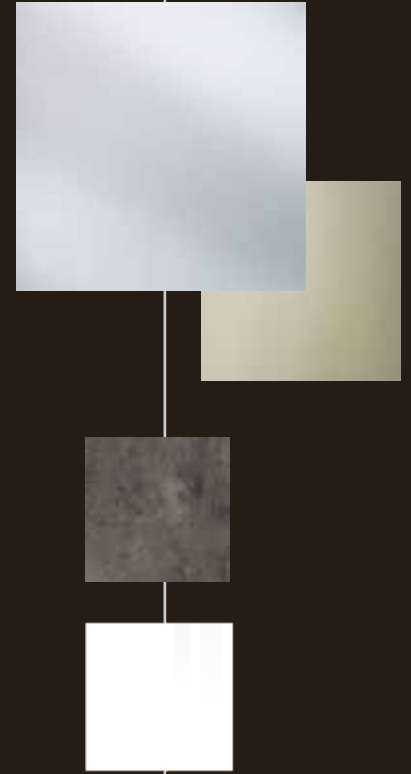

The versatility of sliding doors allows you to incorporate them into any room's design and decor.

A dining room alcove can neatly store tableware and glasses, and even your drinks cabinet, all easily accessible yet out of sight, so you can host a stylish dinner party.

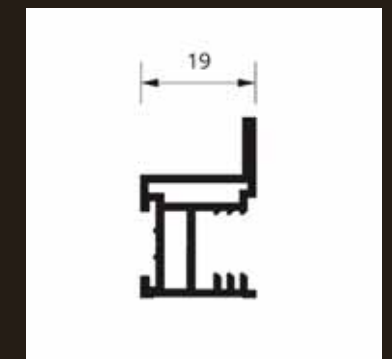
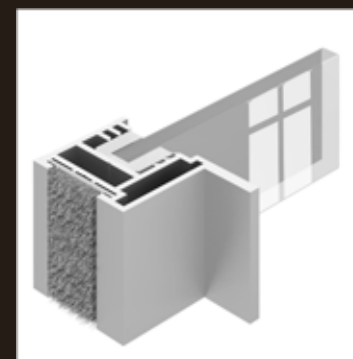



Contour

Traditional and contemporary decors will suit this elegant curved profile.

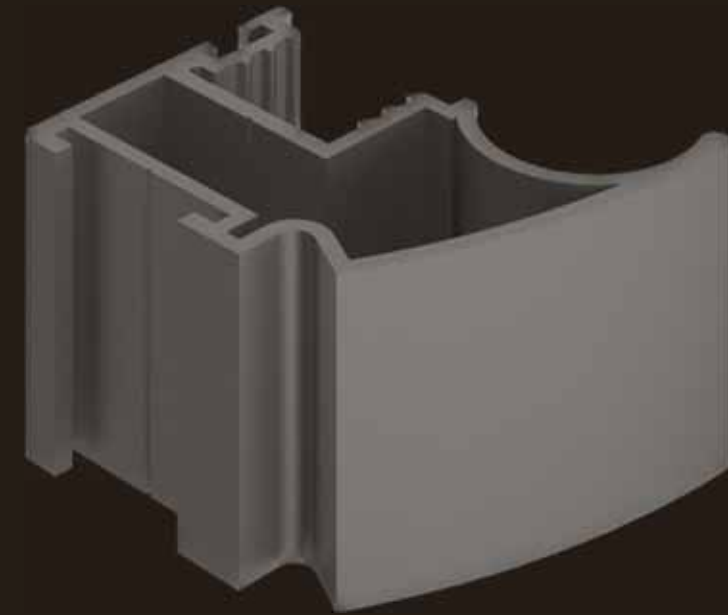

Contour

Secret Hideaways

Contour, Satin Champagne

As a result of its curved profile, the Contour handle is equally suited to both traditional and contemporary decors.

Using the multi-line panel configuration this lounge hideaway features the Contour handle profile in Satin Champagne on three doors.

Panels are in Premium White, Rose Quartz Glass and Silver Mirror.

12.50%
12.50%
25%
25%
12.50%
12.50%

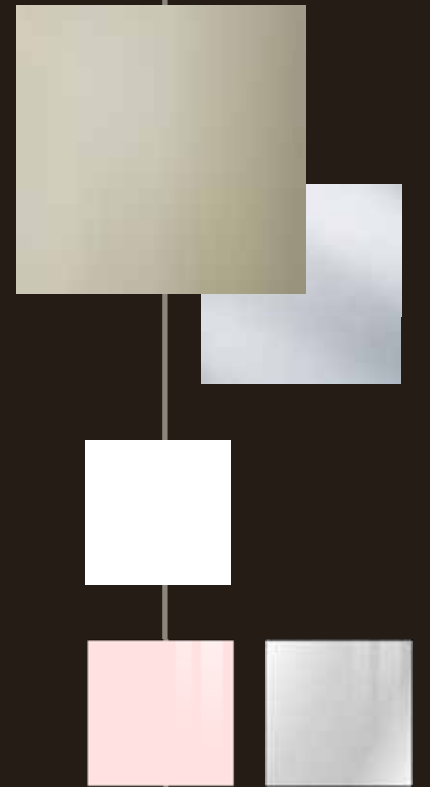

If you wish to neatly and discreetly hide away items such as books and entertainment systems when not in use, sliding doors are the ideal solution.

A sliding door wall adds a unique touch to your living room's decor by creating a feature wall, allowing quick and easy access to items stored behind the doors.

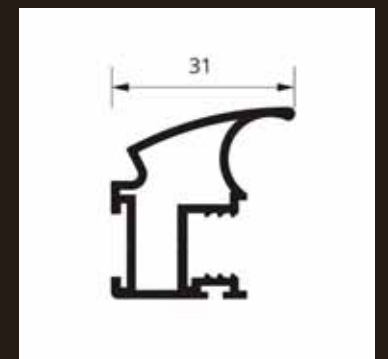
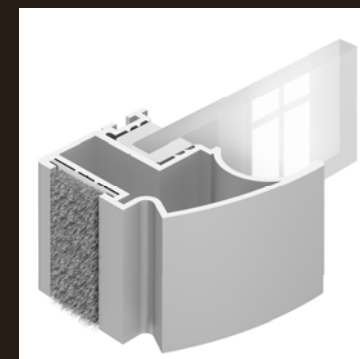

Contour

Mirror Image

Contour, Satin Silver

As a result of its curved profile, the Contour handle is equally suited to both traditional and contemporary decors.

A one-panel configuration is used on all four doors in this modern bedroom, featuring the Satin Silver handle profile.

Panels are in Silver Mirror.

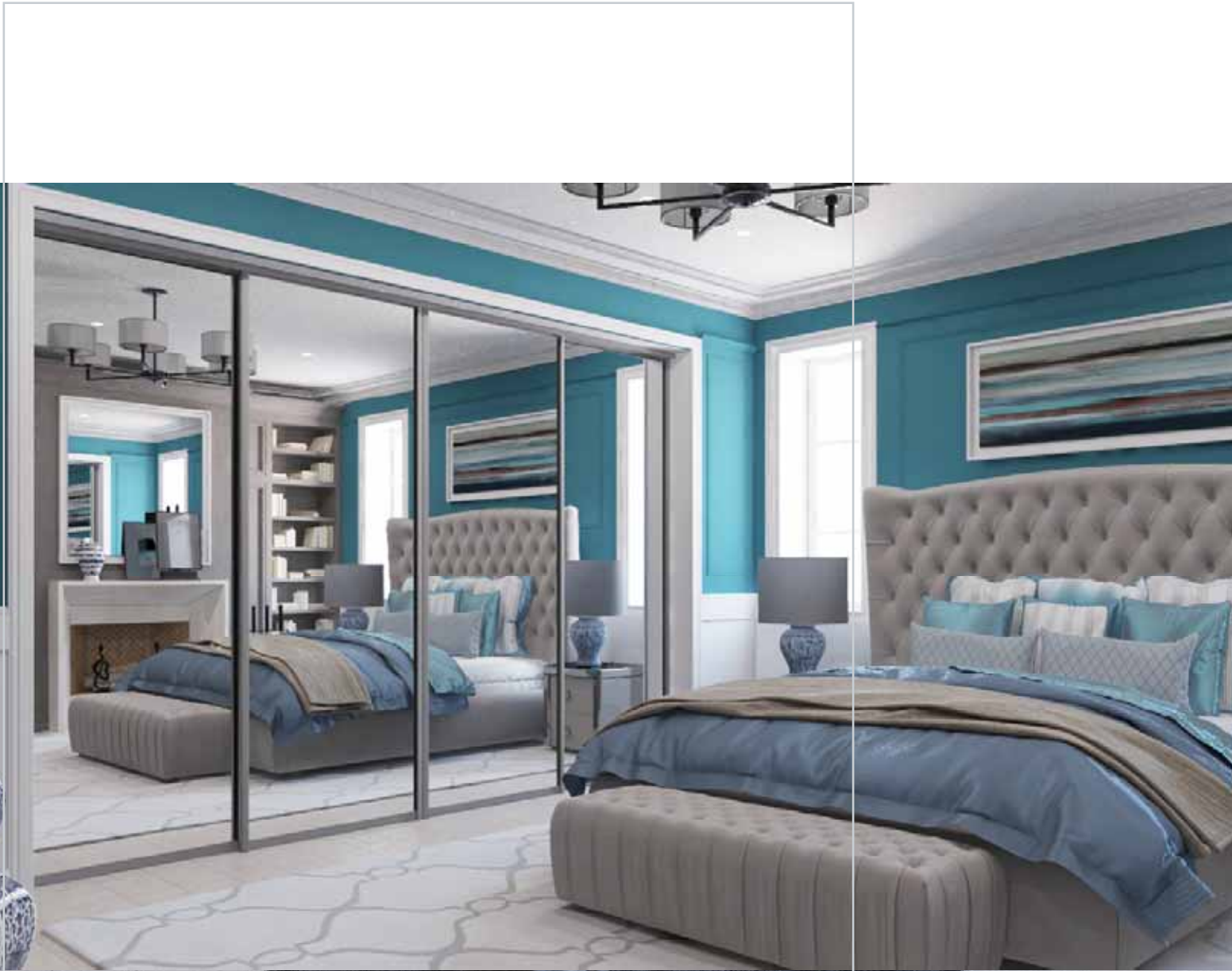
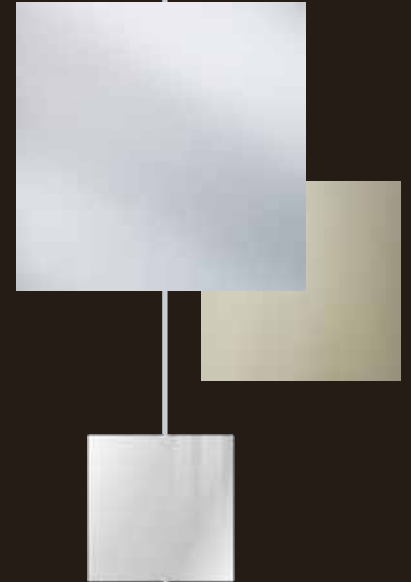

There is no doubt that sliding doors have traditionally been used primarily in bedroom environments.

A sliding door also has the advantage of allowing large mirrors to be integrated into the door, making it perfect for bedrooms and dressing rooms.

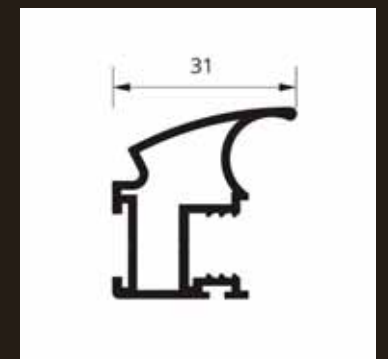
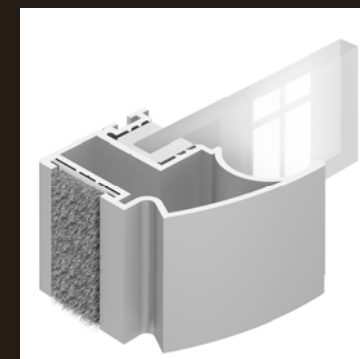



Fineline

This ultra-slim profile offers a modern and minimalist appearance.

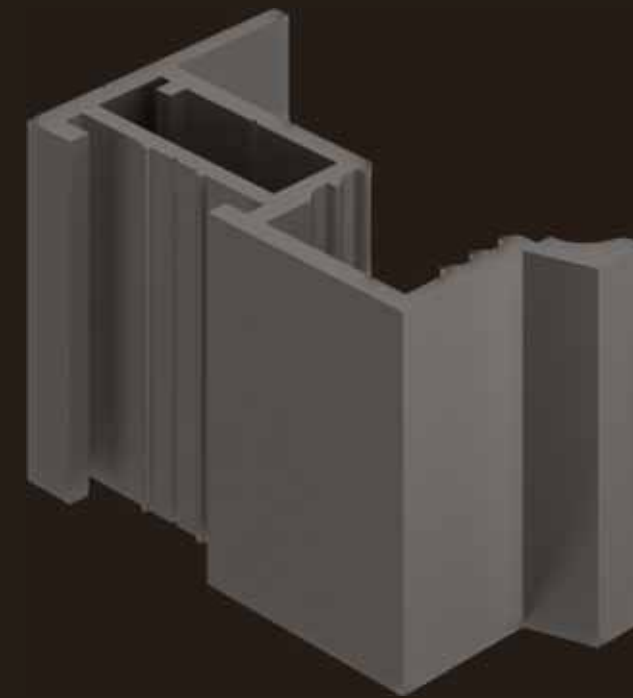

Fineline

Sleek Entertainment

Fineline, Satin Champagne

The Fineline handle profile features a 14mm width, which makes it the slimmest handle profile in the Vetrino collection, giving your doors an extremely contemporary and minimalist appearance.

Using the custom horizontal configuration, this two door sleek entertainment wall uses the Fineline handle profile in Satin Champagne.

Panels are in Grey Brown White River Oak MFC and Chalk Grey Glass.

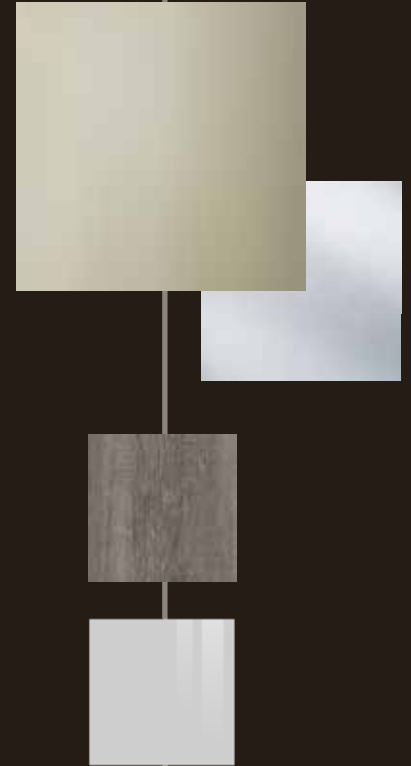
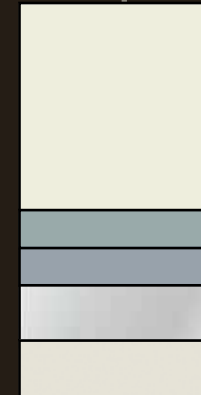

The installation of sliding doors in the living room is a great way to create a feature wall that will add a twist to the decor of the space.

The Fineline profile is the slimmest frame for both MFC panels and glass.

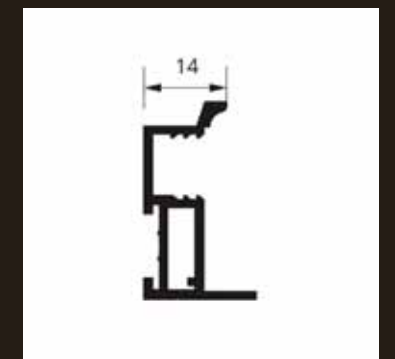
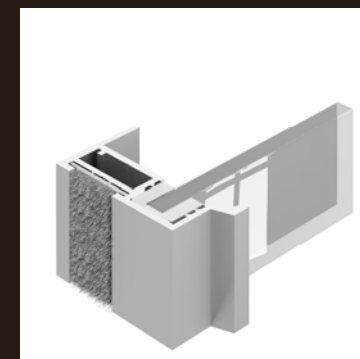

Fineline

Streamline

Fineline, Satin Silver

The Fineline handle profile features a 14mm width, which makes it the slimmest handle profile in the Vetrino collection, giving your doors an extremely contemporary and minimalist appearance.

This contemporary bedroom features the Fineline handle profile in Satin Silver on three doors utilising the three panel configuration.

Panels are in Storm Grey Glass and Silver Mirror.



Adding sliding wardrobes to your space will transform it, you'll have a convenient and space-saving room. When they're made to measure to your interior, they will add a sense of luxury.



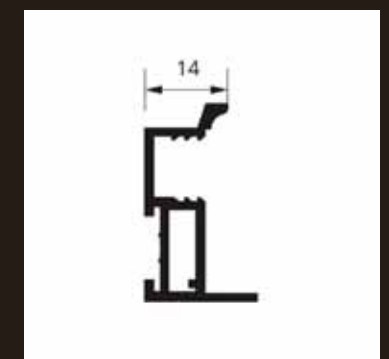
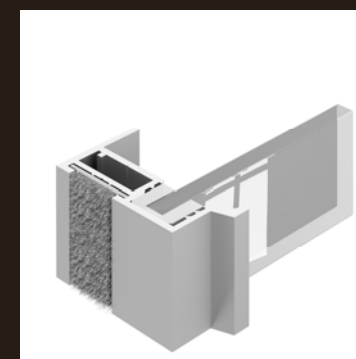





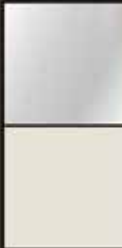

The Fineline profile is the slimmest frame for both MFC panels and glass.



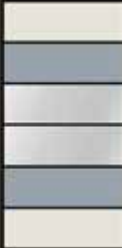
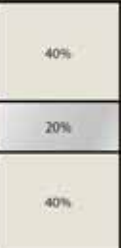
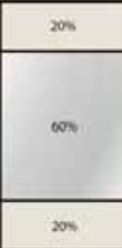
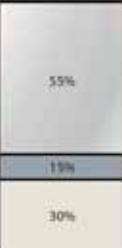
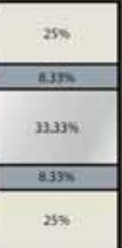
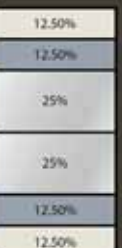

Door designs

When designing your bespoke sliding doors, you have a variety of door styles to choose from. You can also create your own completely unique design.

 1 Panel	 2 Panel	 3 Panel	 4 Panel	 5 Panel	 6 Panel
 Slim Line	 Wide Line	 Low Line	 Break Line	 Multi Line	
 Custom Horizontal	 Custom Vertical	 Vertical 2	 Vertical 3	 Vertical Slim Line	 Vertical Wide Line

A maximum of three custom panels can be ordered per door for vertical styles and up to six panels per door for horizontal styles.

The grain direction of one panel doors will be vertical, and horizontal for two plus horizontal split panels.



Soft close

Innovative components

All of our sliding door systems are fitted with our unique soft closing mechanism for an extra smooth and silent closing action.

The system can be easily fine-tuned and is designed to ensure the soft close is always activated without the need for future adjustment.

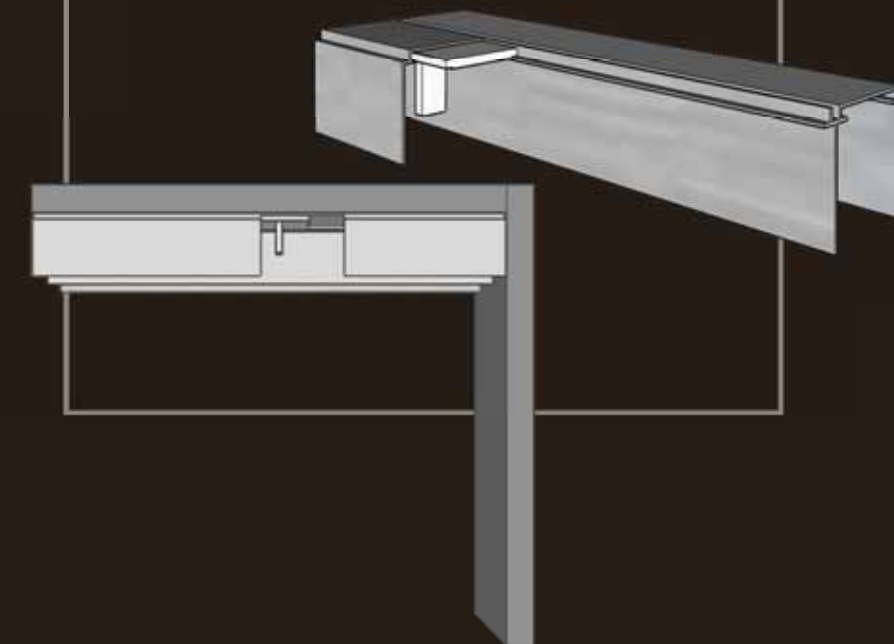



MFC panel decors

MFC Plain

Premium White W1000 ST9	Porcelain White W1200 ST9	Alabaster White U104 ST9	Cashmere Grey U702 ST9
Mussel U100 ST9	Dakar Grey U717 ST9	Pebble Grey U201 ST9	Stone Grey U727 ST9
White Grey U775 ST9	Light Grey U708 ST9	Dust Grey U732 ST9	Onyx Grey U960 ST9
Soft Black U899 ST9	Denim Blue U540 ST9	Indigo Blue U599 ST9	Fjord Green U636 ST9
Fir Green U699 ST9			

The Finline profile can accommodate panels up to 18mm, giving you a wide choice of board options from top brands. Unique board options are available upon request.



MFC panel decors

MFC Woodgrains

<p>Premium White Oak W1000 ST40</p>	<p>Light Grey Oak U708 ST40</p>	<p>Cashmere Grey Oak U702 ST40</p>	<p>Natural Hamilton Oak H3303 ST10</p>
<p>Light Lakeland Acacia H1277 ST9</p>	<p>Kaiserberg Oak H3349 ST19</p>	<p>Natural Nebraska Oak H3331 ST10</p>	<p>Natural Lancaster Oak H3368 ST9</p>
<p>Grey Bardolino Oak H1146 ST10</p>	<p>Shorewood H3090 ST22</p>	<p>Grey Vicenza Oak H3158 ST19</p>	<p>Grey Nebraska Oak H3332 ST10</p>
<p>Beige Grey Lorenzo Oak H3146 ST19</p>	<p>Grey Brown Whiteriver Oak H1313 ST10</p>	<p>Natural Carini Walnut H3710 ST12</p>	<p>Lincoln Walnut H1714 ST19</p>



MFC panel decors

MFC Minerals & textures

 <p>White Chromix F637 ST16</p>	 <p>Beige Textile F416 ST10</p>	 <p>Grey Textile F417 ST10</p>	 <p>Anthracite Linen F433 ST10</p>
 <p>Light Chicago F186 ST9</p>	 <p>Anthracite Metal Fabric F461 ST10</p>	 <p>Anthracite Metal Rock F121 ST87</p>	

MFC Feelwood

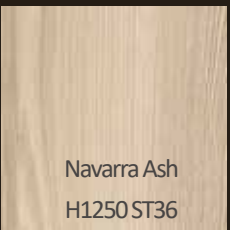
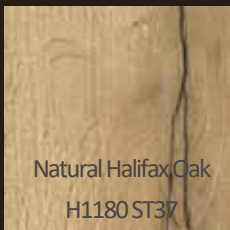
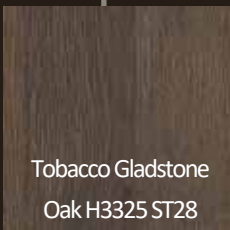
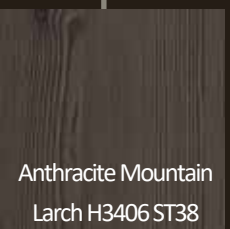
 <p>White Gladstone Oak H3335 ST28</p>	 <p>Navarra Ash H1250 ST36</p>	 <p>Natural Halifax Oak H1180 ST37</p>	 <p>Tobacco Gladstone Oak H3325 ST28</p>
			 <p>Anthracite Mountain Larch H3406 ST38</p>



Mirror & glass

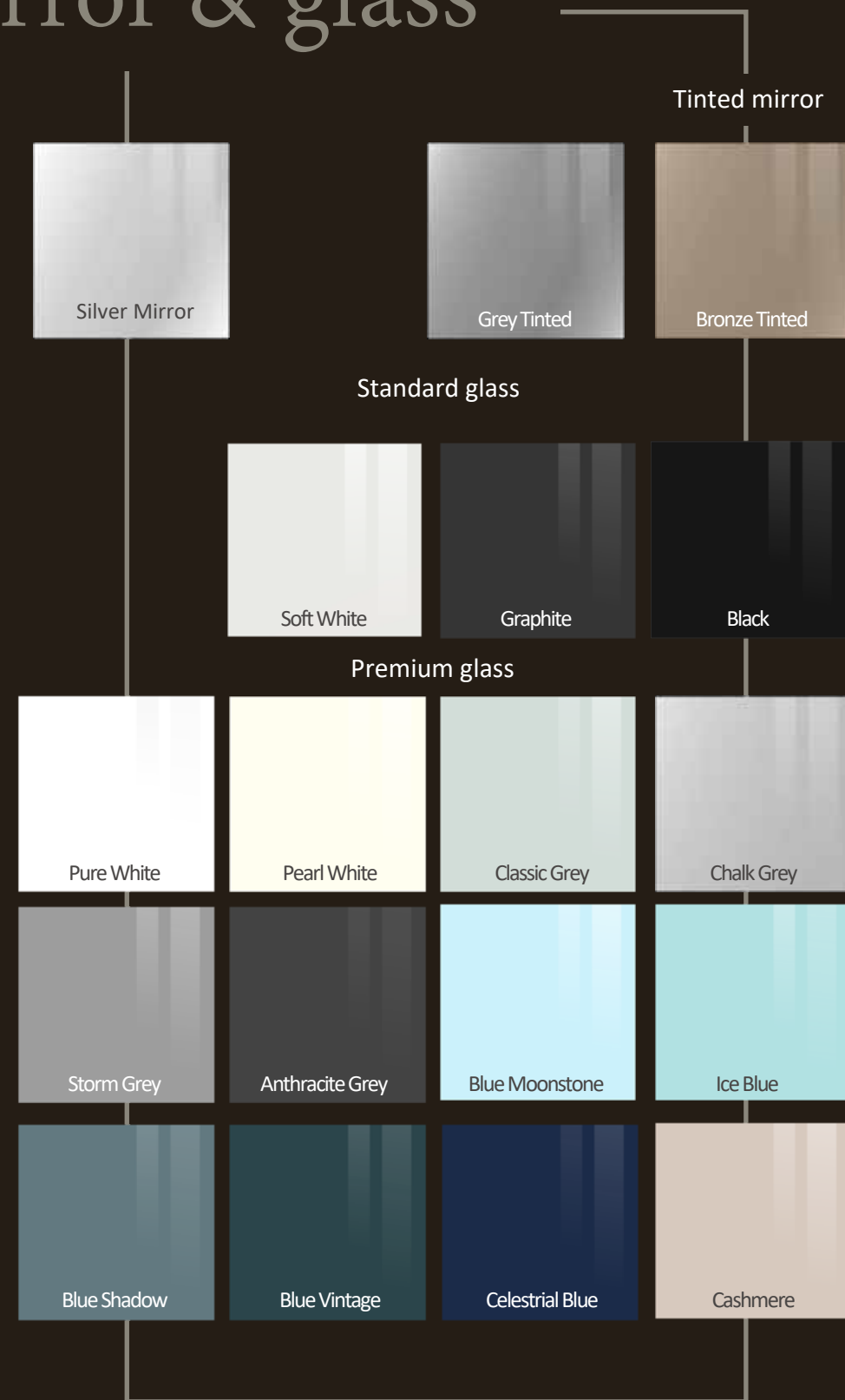



Mirror & glass

Premium glass continued..

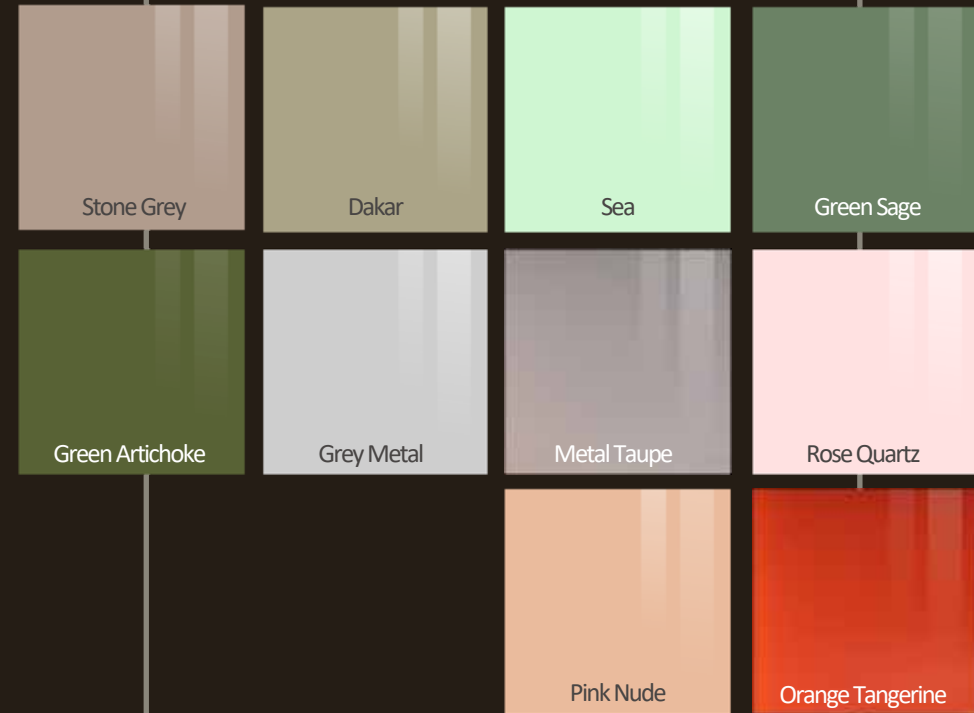

Premium satin glass





Special glass

Its diffusing aesthetic makes obscure glass increasingly popular for sliding doors.

The glass and mirror is cut to size, toughened and safety backed before final assembly.

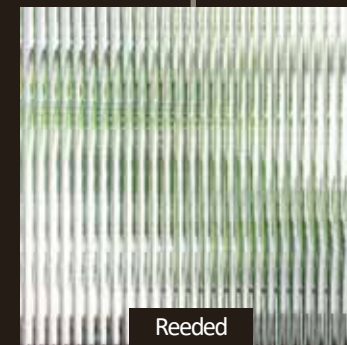

Reeded



Tinted Grey



Antique Bronze



Antique Silver



Rippen



Krizet

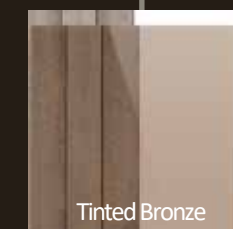

Tinted Bronze

Good Practice

- Maintaining sliding doors will ensure their long-term durability.
- Spills of hot or cold liquid should be wiped away immediately with a dampened micro-fibre cloth.
- Cosmetics, moisturisers, oils, perfumes, varnishes and removers should be cleaned away immediately from any surfaces they touch to minimise surface damage.
- In rooms with fitted furniture, the temperature should be maintained to a reasonable level and the room should be ventilated. Wide swings in temperature, high humidity, and dampness may weaken the furniture's durability and longevity.

It is recommended to clean the doors once a month

- The frames, tracks, and MFC panels should be cleaned with a soft micro-fibre cloth dampened with atomiser water (99 parts water, 1 part washing up liquid), wiped, and then quickly dried with another soft micro-fibre cloth.
- Never use wet cloths or leave water sitting on the surface.
- Do not use coarse or abrasive cloths/sponges, white spirit, turpentine, solvent, glass cleaner, vinegar based, bleaches and other household cleaning products (abrasive or not) on MFC panels. These may irreparably harm the finished surface and will not be covered under any warranty given.
- Using a soft micro-fibre cloth, clean glass and mirror panels with regular household glass cleaner, ensuring that any overspray is wiped away immediately.
- In order to remove dust and small debris from running tracks, a vacuum attachment with soft bristles should be used.

VETRINO

made to measure sliding doors designed for your space





VETRINO

MADE TO MEASURE SLIDING DOOR SYSTEM

